

2VS+DBOX KOKOAMISOHJE
valitse käsisyys, vaihtamalla sohvan ja vuodevaatelaatikon paikkaa

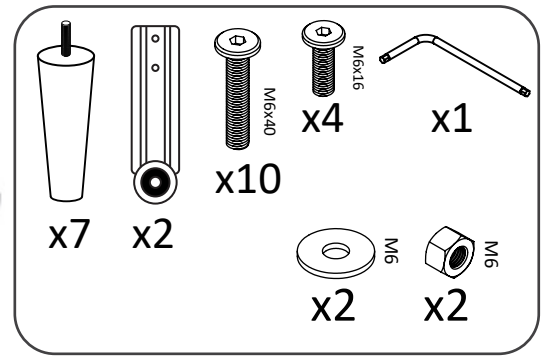

1 Käsinöjien kiinnitys

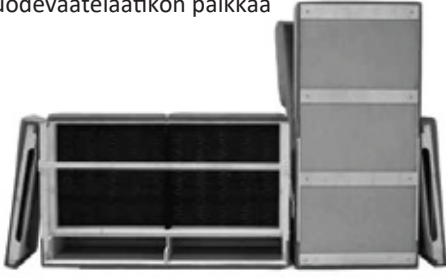
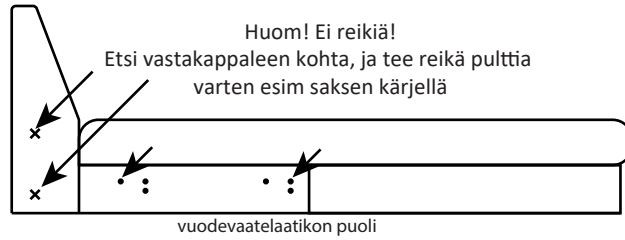
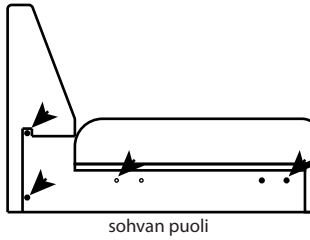
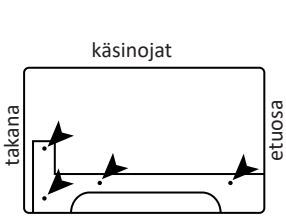
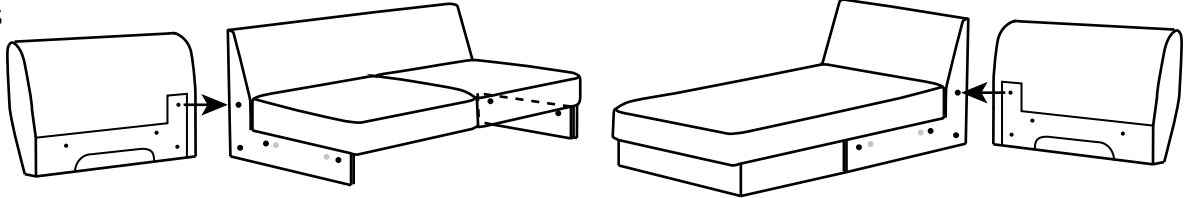
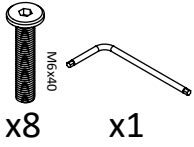

Huom! Ei reikiä!
Etsi vastakappaleen kohta, ja tee reikä pultilla varten esim saksen kärjellä

2 Kiinnittimet

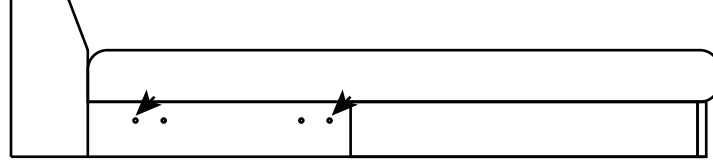
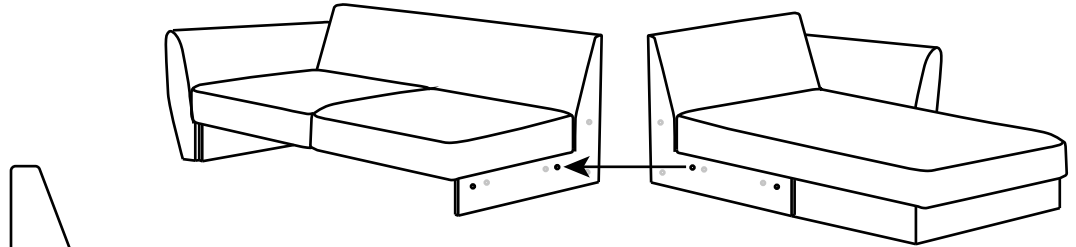
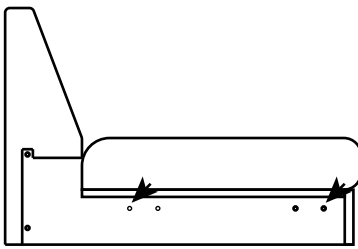
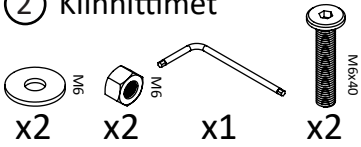

3 pyörät vuodeosaan 16mm pultilla

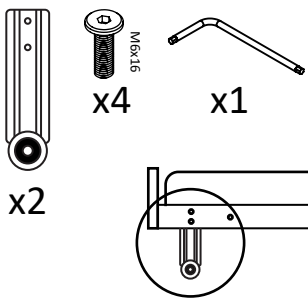

kiinnitä pyörät kuvan mukaisesti
2:lla 16mm pultilla



4 jalkojen paikat

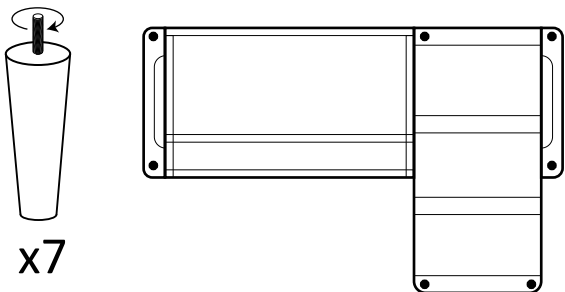

5 laita yhteen

työnnä mekanismi takaisin paikoilleen, nostamalla takaosasta koukkujen yli ja testaa mekanismin toimivuus

