

TÄRKEÄÄ - SÄILYÄ NÄMÄ OHJEET - LUE HUOLELLISESTI KOKOAMISOHJE

-Tarkista ensin pakkauksen sisältö. Kokoa huonekalu numerojärjestyksessä kuvien mukaisesti. Jos kokoaminen tuntuu vaikealta, ota yhteys myymälään.
-Talleta avain. Kalusteiden ruuvit on kiristettävä aika ajoin uudelleen, ettei mahdollinen käytön aikana auennut ruuvi aiheuta tapaturmavaaraa. Tällöin myös huonekalu pysyy tukevana ja kestäää kauemmin.

VIKTIGT - SPARA DESSA ANVISNINGAR - LÄS NOGGRANT MONTERINGSANVISNINGAR

-Kontrollera innehållet i förpackningen. Montera ihop möbelen genom att följa numreringen på bilden. Om monteringen vållar svårigheter bör du kontakta affären.
-Spara sexkantsnyckeln. Skruvarna måste spännas då och då, eftersom de med tiden kan bli lösa och därmed medföra risk för olycksfall. Samtidigt försäkras du dig om att möbelen är stabil och att den håller längre.

IMPORTANT - KEEP THESE INSTRUCTIONS - READ CAREFULLY ASSEMBLY INSTRUCTIONS

-Check the contents of the package first. Assemble the furniture as shown in the diagrams, in the order indicated by the numbers.
-If assembling the furniture seems difficult, contact the furniture shop.
-Keep the spanner in a safe place. The screws will need to be tightened once in a while so that any screws that may have loosened during use will not cause an accident harming.
An occasional re-tightening of the screws keeps the furniture stable, which makes it last longer.

ВНИМАНИЕ - СОХРАНИ ЭТУ ИНСТРУКЦИЮ - ПРОЧИТАЙ ВНИМАТЕЛЬНО ИНСТРУКЦИЯ ПО СБОРКЕ

- Сначала проверьте содержимое пакета. Собирайте мебель поэтапно согласно чертежу. Если возникли трудности, свяжитесь с магазином.
- Сохраните ключ. Все винты мебели необходимо закреплять время от времени, мебель тогда будет более устойчивой и прослужит дольше.

CUBIC Lipasto + Ovi!

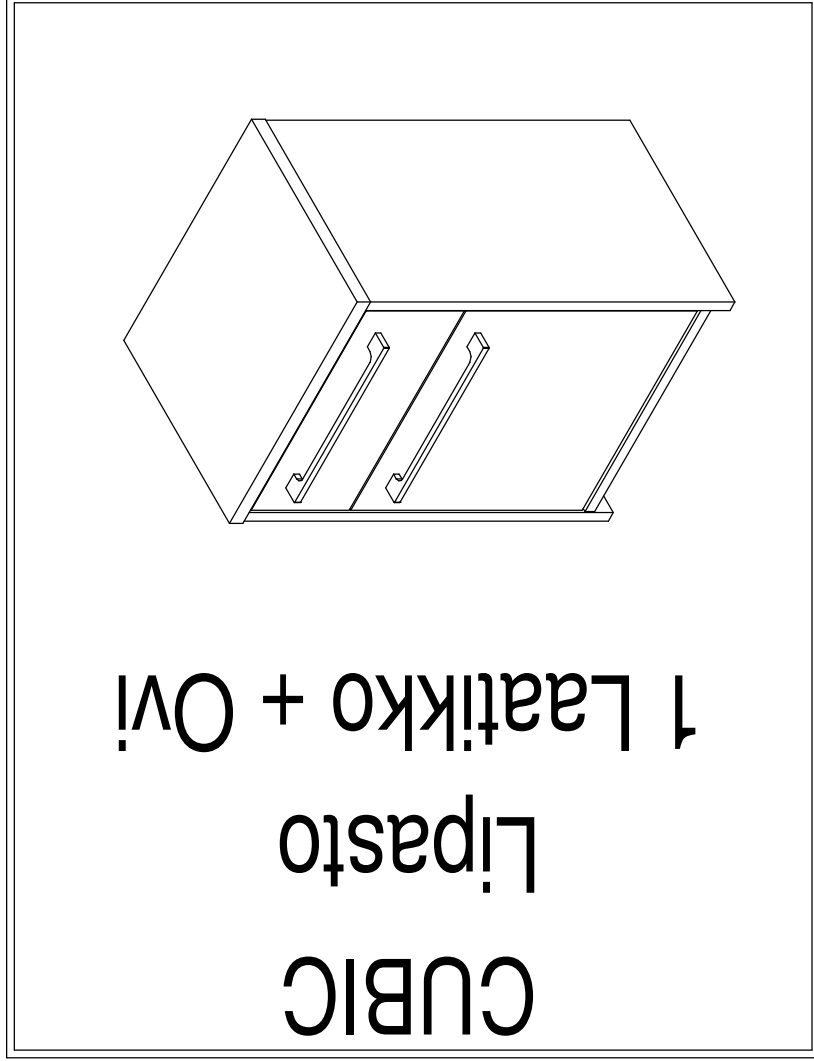

NIEMEN TEHTAAT OY
Teollisuuskatu 7
FIN 38210 Sastamala

Tel: +358-(0)3-5124600
Fax: +358-(0)3-5124610
www.niementehtaat.fi

BYNIEMI

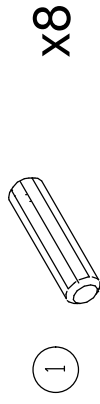

1

x8

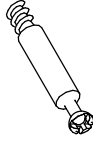

2

x10



3

x8

15mm



4

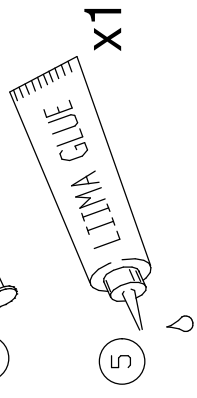

5

x1

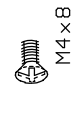

6

x2

M4x8



7

x2

12mm

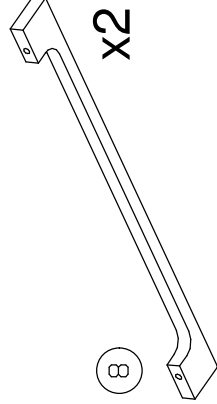

8

x2

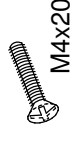

9

x4

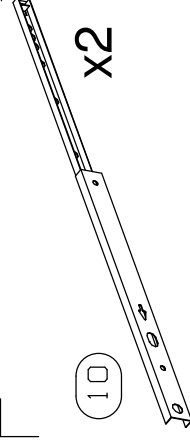

10

x2



11

x4

6x8



12

x4

3,5x15

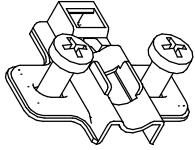

13

x2

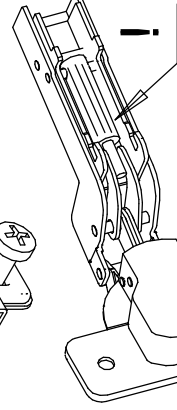

14

x1

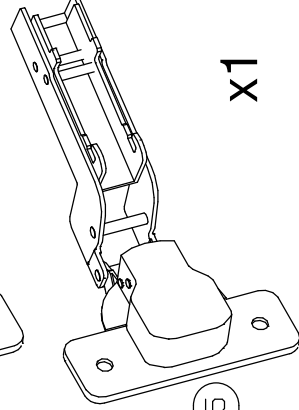

15

x1

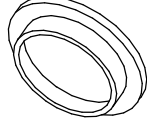

16

x2



17

x1



1

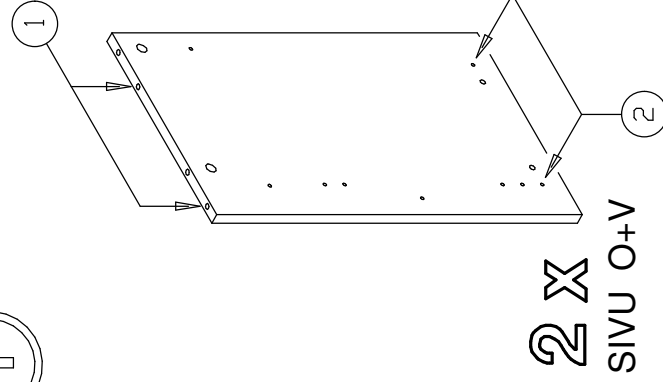

2 X
SIVU O+V

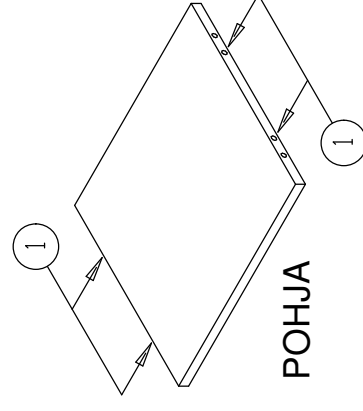

POHJA

KANSI

2

KANSI

SIVU V

POHJA

SIVU O

Tarkista lipaston suoruus "ristimittamalla" se kulmasta kulmaan ennen taustalevyjen kiinnittämistä.

5

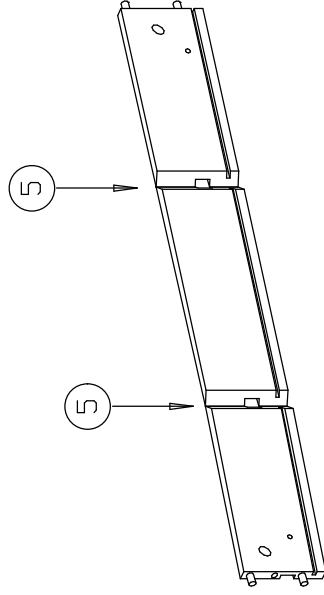

6

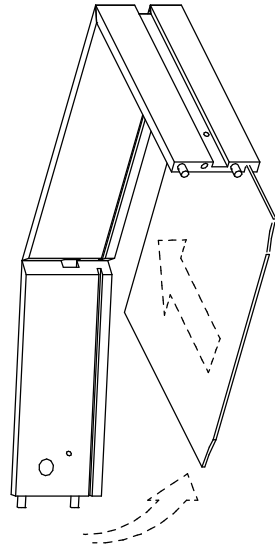

3

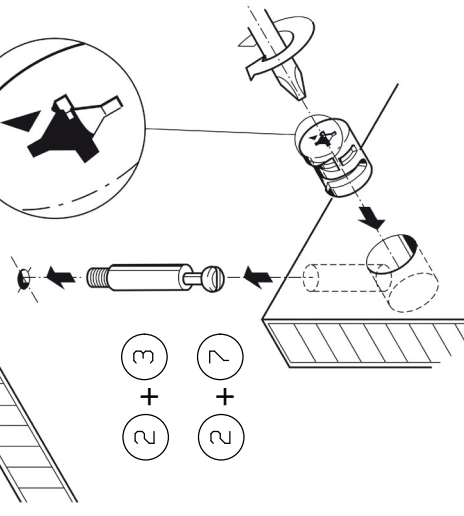
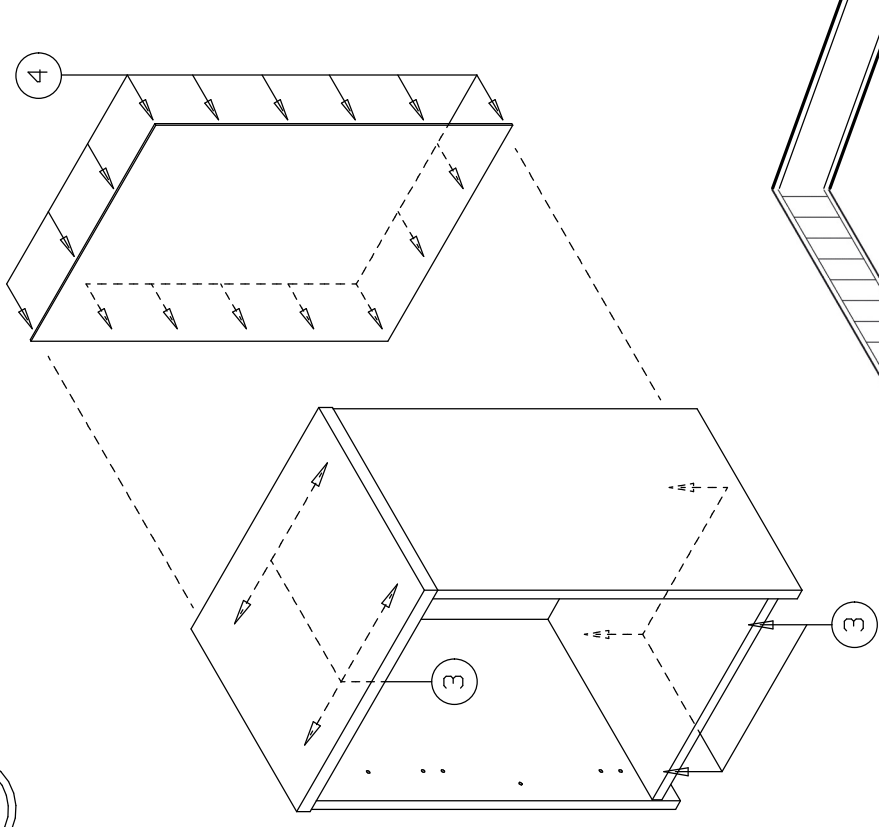

Saranan asennus ja irroitus

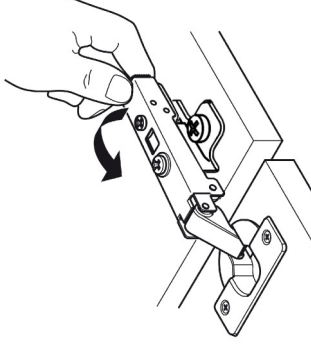
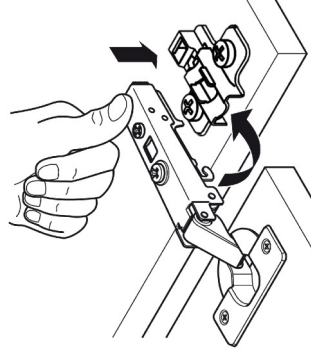

Saranan säätö

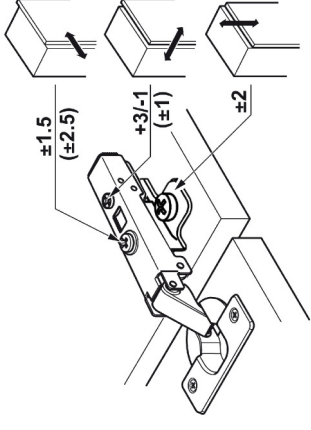

4

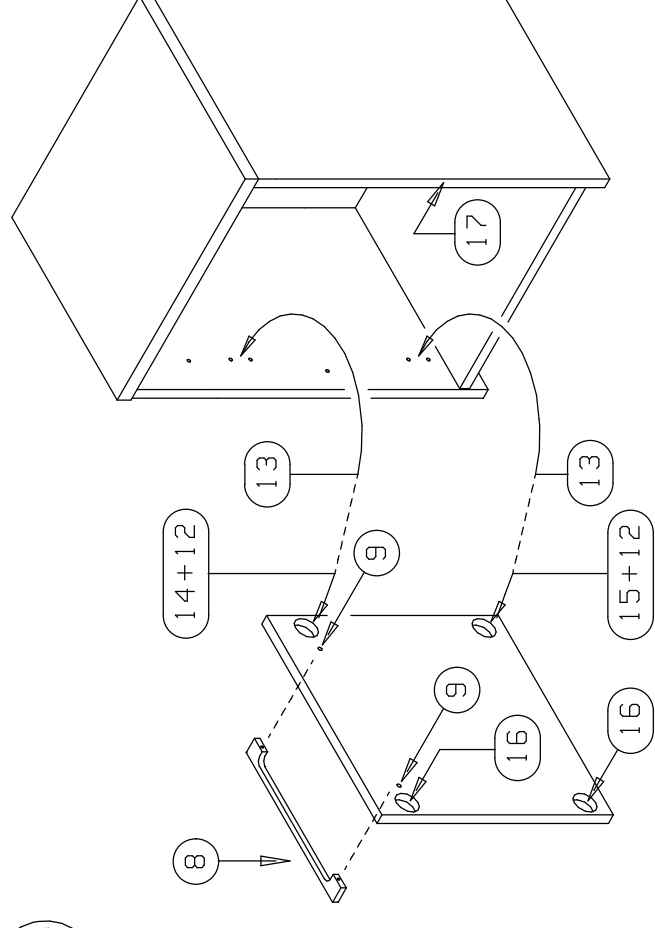

7

