







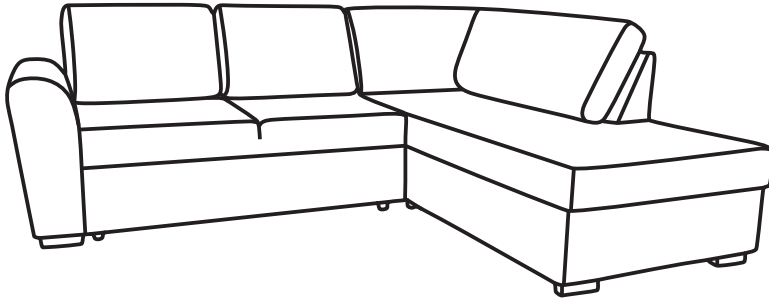

SOTKA

LUGO





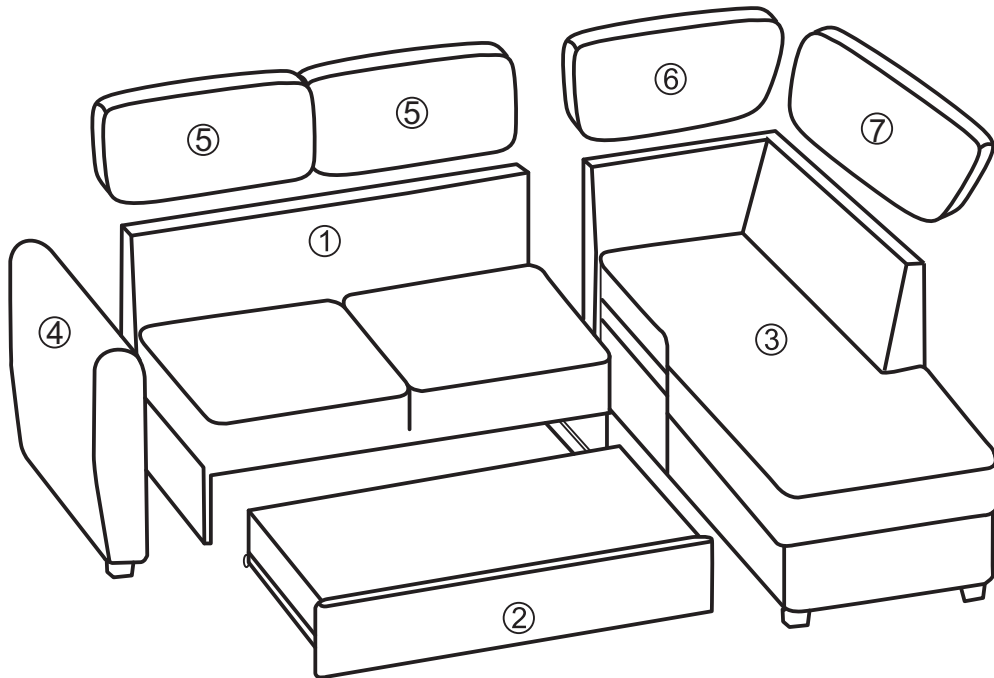

1350+OE STAL

11-05/2016

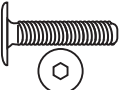

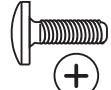
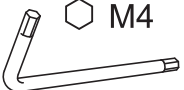
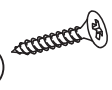
 x2	 60 MIN		
			

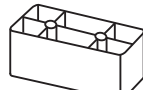

A		A x3 M6x40	B		B x3 M8x24	D	 Felt Feutre	D x11	E		E x4 M6x35
G	 M4	G x1	H		H x6 M5x50	I		I x3	J		J x4
K		K x1 M5x40									

