

***Assembling instruction***

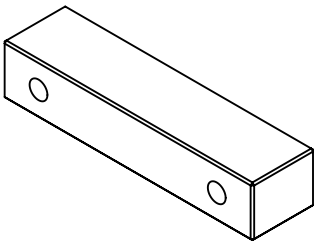

x4

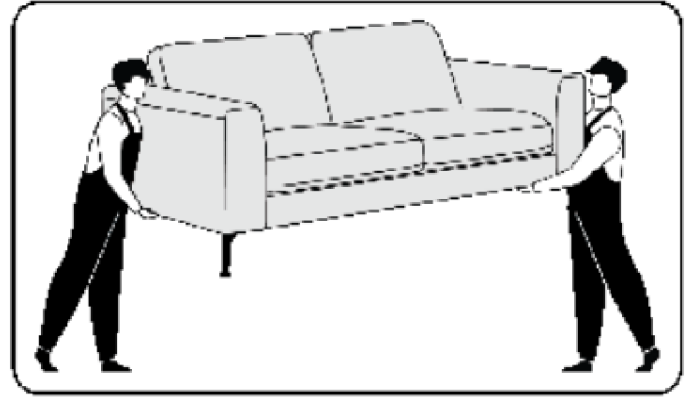
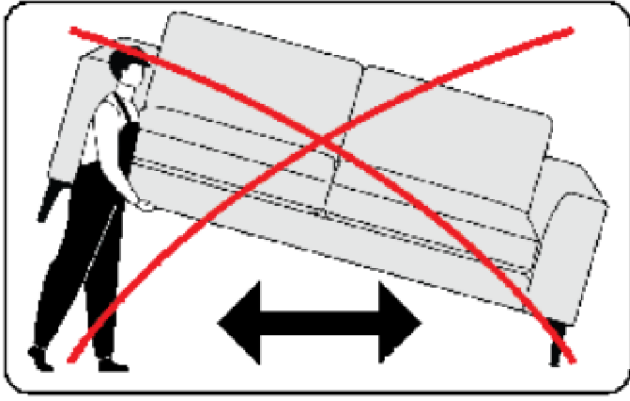
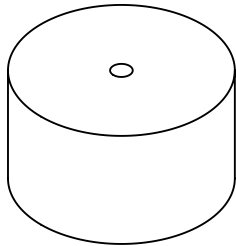

x8

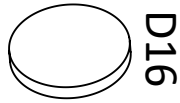

x8

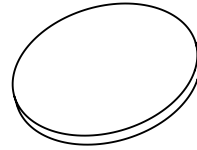

x8

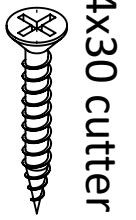

x16

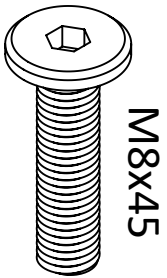

x2

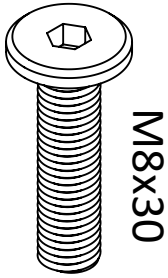

x2

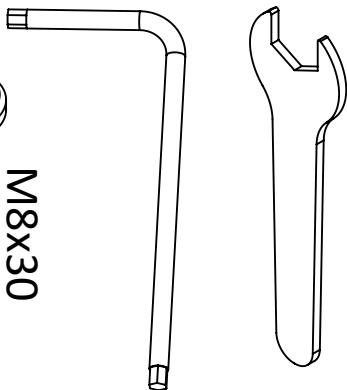

x1

x1



x4

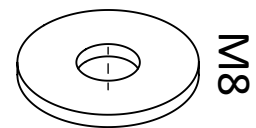

x4

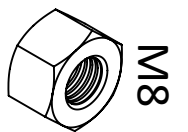

x4

